

MRI SAFE

Bipolar Lead

Model: 3851 VB PRO MRI

*MRI Safe
Coronary Venous
Steroid-Eluting
Bipolar
Pace / Sense Lead*

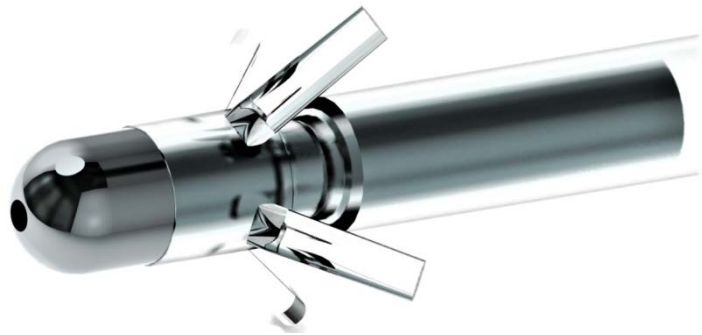

TECHNICAL / PHYSICIAN MANUAL



Shree Pacetronix Ltd.

Plot no. 15, sector II, Pithampur
454775, District: Dhar,

Madhya Pradesh

Phone No.: 07292 411105

Fax No. : 07292 400417

Email: pacetrnix@hotmail.com

Website: www.pacetrnix.com

Revision History

Revision	Date	Change Description
03	July 4 th , 2015	New EC Rep
04	August 1 st , 2016	Information
05	December 1 st , 2017	Information
06	August 4 th , 2020	Reviewed, Added more Information

Bipolar Lead
Model: 3851 VB PRO MRI

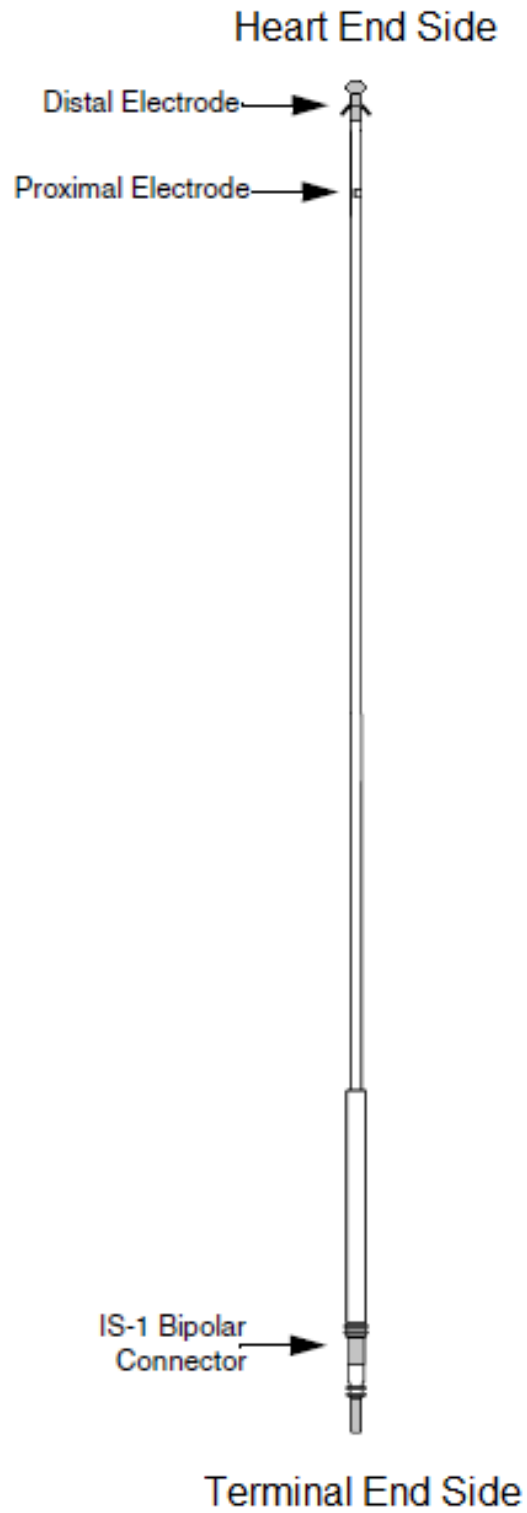

Contents

	1
1	DESCRIPTION	7
	<i>Device Description</i>	7
	<i>Indication For Use</i>	9
	<i>Contraindication</i>	9
2	SPECIFICATIONS	10
	<i>Specification</i>	10
	<i>Accessories Specification</i>	12
3	PACKAGE INFORMATION	13
	<i>Contents of Sterile Package</i>	13
	<i>Handling & Storage</i>	13
	<i>Outer Package</i>	13
	<i>Inner Package</i>	14
	<i>Shelf Life</i>	14
4	MRI TEST	15
	<i>Care in MRI Test</i>	15
	<i>Parameters at MRI test</i>	16
5	IMPLANT INFORMATION	18
	<i>Included Item</i>	18
	<i>Opening Instruction</i>	18
	<i>Sterilization</i>	18
	<i>Surgical preparation</i>	19
	<i>Lead Accessories</i>	19
	• Stylets	19
	• Suture Sleeves	20
	• Vein Pick	20
	<i>Handling the lead</i>	21
6	IMPLANT PROCEDURE	22
	<i>Opening a Sterile Package</i>	23
	<i>Verify lead and connector compatibility</i>	23
	<i>Inserting the stylet</i>	23
	<i>Inserting the lead</i>	24
	• Cephalic Vein	24
	• Subclavian Vein	25

	<i>Using the vein lifter</i>	26
	<i>Using the lead introducer</i>	26
	<i>Positioning the lead</i>	27
	• Ventricular Lead Placement	27
	<i>Test the lead system</i>	27
	<i>Lead Fixation</i>	29
	<i>Checking lead stability</i>	29
	<i>Repositioning the lead</i>	29
	<i>Intra-operative measurement</i>	29
	• Connection to Pacing System Analyzer	30
	• Recommended electrical parameter values	30
	<i>Securing the Lead</i>	31
	<i>Percutaneous Implant technique</i>	32
	<i>Venous Cutdown Technique</i>	32
	<i>Connect Lead to the Device</i>	33
	<i>Test the pacemaker operation</i>	35
	<i>Position & secure the pacemaker</i>	35
	<i>Lead extraction</i>	36
	<i>Explantation</i>	36
7	WARNINGS	37
	<i>Inspecting the sterile package</i>	37
	<i>Sterilization</i>	37
	<i>Magnetic resonance imaging (MRI)</i>	37
	<i>Diathermy treatment</i>	37
8	PRECAUTIONS	38
	<i>Sterilization and Handling</i>	38
	<i>Lead Evaluation and implantation precautions</i>	38
9	POTENTIAL ADVERSE EFFECTS	40
10	SYMBOLS	41
	<i>Explanation of Symbols</i>	41
11	SIDE EFFECTS	42
12	TECHNICAL SERVICE	42
13	FIGURES	43
14	TABLES	44

15	DISCLAIMER OF WARRANTIES.....	44
16	GLOSSARY.....	45

Technical Manual

1

DESCRIPTION

Device Description This document is a Technical / Physician manual of **MRI Safe** coronary venous pace/sense, steroid eluting **Bipolar lead Model 3851 VB PRO MRI**. This manual contains the specification, implant information, warning, precaution etc. of Bipolar lead Model 3851 VB PRO MRI .

Product type:

Lead Name	Lead Model	Type
Bipolar Lead (MRI safe lead)	3851 VB PRO MRI	Endocardial Passive Fixation, MRI compatible lead

Besides all the information concerning specification, Accessories, implant procedure, data measurement can be obtained from this document.

A pacing lead consist of one or more conductors insulated with a sheath of material such as silicone rubber, polyethylene or polyurethane and is intended for use with pulse generators for long term cardiac pacing. Although the insulating materials have been shown to the body compatible, they are nevertheless prone to attract foreign particles such as dust and lint. Therefore, care should be exercised to ensure that no contamination occurs before introducing into the body.

Implantable cardiac pacing leads are commercially available in a vast array of different configuration, each designed to provide a particular advantage in a given clinical situation.

The scope of this instruction is limited to a discussion of permanent pacing leads available from the manufacturer and is intended only as a general overview on the handling and techniques of insertion of these leads.

Recommendation (is limited to a discussion of permanent pacing leads available from the manufacturer and is intended) for the proper use are given. Within this context these instructions may serve a useful guide. Although these instructions are based on user experience, the physician may wish to vary the implantation procedure in accordance with clinical judgments.

Defibrillation instrument must be placed on standby and be kept

immediately available during the time of lead insertion and pulse generator connection. The physician should be familiar with pacing, surgical procedure and emergency life support.

**Bipolar Lead
Model 3851 VB
PRO MRI
(MRI SAFE)**

Pacetrnix Bipolar lead Model 3851 VB PRO MRI leads are transvenous *passive fixation*** leads designed for use with single or dual chamber implantable pulse generators that accept leads with a bipolar IS-1 connector configuration. The leads are constructed with multifillar conductors insulated with medical grade silicone and feature four silicon tines for passive fixation in the heart.

The tip electrode is having fractal surface structure that provides a larger effective tissue interface; it is this interface that is a major factor in determining a lead's sensing characteristics. The half sphere shaped tip electrode has a base material of titanium. The ring material has a base material composed of medical grade SS.

The Bipolar lead Model 3851 VB PRO MRI leads are *MRI safe* steroid-eluting, bipolar implantable pacing leads. These leads have straight distal ends are intended for pacing and sensing in the ventricle.

Bipolar lead Model 3851 VB PRO MRI is MRI compatible lead (Refer: MRI).

The electrode surfaces have been coated with the steroid dexamethasone sodium phosphate.

Each electrode contains a maximum of 1.0 mg of dexamethasone sodium phosphate, a portion of which is in a silicone rubber binder. Upon exposure to body fluids, the steroid elutes from the electrode. Steroid suppresses the inflammatory response that is believed to cause threshold rises typically associated with implanted pacing electrodes.

The leads also features an MP35N nickel-alloy conductor, silicone rubber insulation, and a bipolar connector (IS-1* BI).

*****Passive
Fixation Lead***

A passive fixation lead is used to send the electrical signal of the device to the heart. The term "passive" indicates only that the lead is attached to the heart muscle without a mechanism that holds the end of the lead against the heart muscle. Passive leads are held against the heart muscle by the pressure exerted by the leads slight stiffness and shape, or by small tynes that grab the lining structures on the inside of the heart.

****IS-1*** *IS-1 refers to the International Connector Standard (see Document no ISO 5841-3) whereas pacemaker and leads are assured of meeting the electrical and mechanical parameters specified in the*

IS-1 International Standard.

The pacing lead combines the benefits of pacing therapies.

- Bipolar
- *MRI Safe*
- Passive fixation
- Straight lead tips
- 7.0f

Indication For Use

The leads are designed for use with implantable pulse generators that require pacing leads with a bipolar 3.2 mm IS-1 connector configuration; they may be used with single or dual pacing systems. The lead is designed for permanent sensing and pacing in either the atrium or the ventricle, in combination with a compatible pulse generator.

Permanent cardiac pacing is indicated in presence of certain congenital or acquired impulse-formation and conduction disorders of the heart. Specific indications include but not limited to: sick sinus syndrome, sinus bradycardia, complete heart blocks, symptomatic second degree heart block and certain conditions of asymptomatic second degree block.

The lead is used in conjunction with an implantable pulse generator. A variety of pulse generators can be used in combination with lead. The lead will connect directly to many commercially available pulse generators. Some pulse generators will require the use of a commercially available adaptor to make the connection to the lead.

Contraindication

The use of endocardial leads may be contraindicated in the presence of certain gross abnormalities of the heart such as:

- In the presence of tricuspid Artesia.
- Ebstein's malformation
- Various form of atrial or ventricle transposition.
- In patients who are expected to be hypersensitive to a single dose of one milligram of dexamethasone sodium phosphate.

2

SPECIFICATIONS

*Specification***Table 01: Bipolar Lead Model 3851 VB PRO MRI Specification (MRI safe)**

COMPONENTS	Bipolar Lead Model 3851 VB PRO MRI
Chamber	Ventricle
Polarity	Bipolar
Shape	Straight
Lead Length	56.5 ± 0.5 cms
Fixation	4 tines
Connector	IS-1 BI
Conductor Material	MP35N
Insulation material	Silicon (Medical grade)
TIP electrode material & Shape <i>(Heart end side)</i>	Titanium , Hemisphere
Bush electrode material <i>(Heart end side)</i>	SS (Medical grade)
Terminal End pin	SS (Medical grade)
Terminal End Bush	MP35N
Diameter Lead body	2.2 ± 0.05 mm

Diameter Connector (‘TIP’ Terminal end)	1.55 ± 0.05 mm
Diameter Connector (‘Ring’ Terminal end)	2.6 ± 0.05 mm
Diameter Bush Electrode (Heart end)	2.0 ± 0.05 mm
Diameter Tip Electrode (Heart end)	2.0 ± 0.05 mm
Distance between electrodes (Terminal end)	5 ± 0.05 mm
Distance between electrodes (Heart end)	10 ± 0.05 mm
Lead Introducer	7F
Electrode configuration	Endocardial Passive Fixation
Steroid	Dexamethasone sodium phosphate (DSP)
Suture Material	Silicon
Suture Sleeve length	17 ± 0.05mm
Suture Sleeve Grooves	3 grooves
Lead Weight	4.89 ± 0.5 gms
Electrode Surface Area	
TIP	6.0 mm ²
Ring	25.0 mm ²
Resistance	35 ± 5 ohms (Inner) 50 ± 5 ohms (Outer Coil)
Stylet Details	
Inserted	Red (Straight & hard)

Packaged	Red (Straight & hard) – 1 Blue (Straight & Soft) – 1
Length	59 ± 0.5 cms

Accessories Specification

Table 02: Accessories: Bipolar Pacing Lead Model 3851 VB Specification

Accessories	Parameters
Vein Lifter	
Dimension (mm)	Length : 66.0 mm, Width : 3.2 mm, Thick : 1.60 mm
Weight (gms)	1.19 gms
Material	Plastic (Medical grade)
Stylet (Hard & Soft)	
Diameter	0.35 mm ± 0.03
Length	59 cm ± 0.5 (for 58 cm lead) 55 cm ± 0.5 (for 53 cm lead)
Weight	1.41 gm
Blue & Red handle diameter	7.0 mm ± 0.5
Material of stylet Wire	SS (Medical grade)
Material (Handle)	Plastic (Medical grade)

3

PACKAGE INFORMATION

Contents of Sterile Package The content of the package are sterile. Each package contains:

- One Lead.
- One suture sleeve attached to the lead.
- One Vein lifter
- Three stylets
 - One soft^a, straight tapered ball tipped stylet.
 - Two hard^b, straight tapered ball tipped stylets.
- Literature pouch
 - Lead Serial & Model number stickers
 - Lead Manual

a. Blue handle, 0.014 inch (0.35 mm) diameter

b. Red handle, 0.014 inch (0.35 mm) diameter

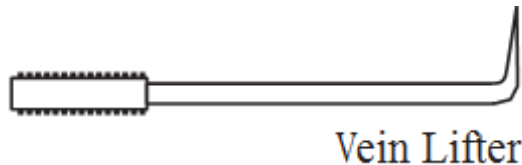

Figure 1: Lead accessories

Handling & Storage The Lead can be damaged if it falls down on a hard surface. Do not implant the lead if the **package is damaged**. Damaged packages must be returned to the Shree Pacetronix Ltd.

The lead should not be stored for long periods in rooms where the temperature can exceed 50°C (122°F) or under -5°C

Storage temperature range: -5°C (23°F) to 50°C (122°F).

Outer Package The lead is delivered in an outer cardboard package sealed in plastic film. The package label, including model designation, serial number, and the “Use Before” date for implantation.

Before opening, verify:

- (1) The package has not been damaged, punctured or otherwise compromised.
- (2) The lead contained is suitable for your application. Do not implant if

the "Use Before" date has expired.

Note: *The lead and its accessories should be kept inside their sterile package until implantation.*

Inner Package Inside the cardboard box is an outer tray containing a sterilized inner tray. The inner tray contains the lead and its accessories. In order to preserve sterility, operating room procedures should be followed when opening the outer tray.

Caution Only a person prepared for the sterile field may handle the sterile inner tray. Use only powder-less, sterile surgical gloves when handling the Lead.

Tear the label off the tray to reveal the sealed inner tray (*Figure 2*). When ready, tear open the inner tray (*Figure 3*).



Figure 2:

Opening the outer tray may be done by a person not prepared for the sterile field.

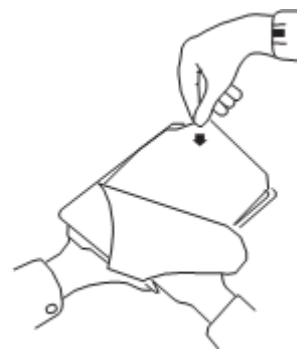

Figure 3:

Only a person prepared for the sterile field may open the inner tray.

Shelf Life Shelf life of sterilized device is 2 years from the date of sterilization.

A magnetic resonance imaging (MRI) is a type of imaging that uses magnetic fields to construct an inside view of the body, which helps doctors for diagnostic purposes. You can undergo an MRI scan if your pacing system consists of Pacetronix MRI safe pacemaker and MRI safe leads.

Note: *Ensure both Pacemaker & Lead are MRI safe prior to MRI test.*

The electromagnetic fields of MRI scans have the potential to cause hazardous effects on pacemakers as well as lead, which can result in cardiac tissue heating, inappropriate pacing, and dangerous arrhythmias.

These risks are reduced to a very low level so that under specified conditions, patients may safely undergo MRI scans.

The MRI pacemaker and its leads should be used in the MRI environment. Any other pacing system combination may result in a hazard to the patient during an MRI scan. When MRI feature is ON, it allows the patient to go under MRI scan safely while the device pace continuously.

MRI scanning is prescribed by your physician. This is not a common treatment. Please consult with your doctor. Your doctor should discuss all potential benefits and risks with you.

Care in MRI Test Following should be taken care----

1. Patient should undergo MRI scanning at least after 2 months period of Implantation.
2. Before going for MRI pretesting of pacemaker is required and parameters should be noted.
3. Pacemaker should be programmed in MRI safe mode before undergoing MRI test.
4. It should be programmed with Pacetronix MRI compatible software.
5. The Lead impedance should be in the range of 400 to 900 ohms.
6. Pacing threshold should be less than 1.5 V.

Transmit and Receive coils should not be placed directly over the pacing system because this has not been evaluated and such use is contraindicated.

Patients having diaphragmatic stimulation at a pacing output of 5.0 V and pulse width of 1.0 ms are contraindicated for an MRI scan.

7. Before going for MRI the pacemaker should be programmed with MRI "ON" with below parameters.

Parameters at MRI test Pacemaker parameters (at MRI scanning), to be programmed, are as below:

Mode	VOO/DOO
Amplitude	5.0V
Rate	70ppm or As suggested by Doctor
Pulse width	0.5 ms
MRI Safe	ON

8. The whole body averaged specific absorption rate (SAR) must be < 2.0 Watts per kilogram (**W/kg**).
9. The head SAR must be < 3.2 W/kg.
10. Pacemaker is tested in 3T (Tesla) Field. Please refer report. It's a bench testing to check MRI effect on pacemaker's functioning, heating effect and image artifacts.
11. During MRI test, ECG should be monitored and Defibrillator also should be kept ready.
12. After MRI the pacemaker should be tested for impedance and pacing threshold and these should be within range.
13. After testing pacemaker should be programmed back to normal parameters.
14. Kindly make a record, if any heating effect is sensed by the patient at pacemaker or electrode site.
15. Please note of any arrhythmia, discomfort to the patient.
16. Please send complete MRI report to Pacetronix with its images along with doctor's comments.

Physician Manual

5

IMPLANT INFORMATION

Proper surgical procedures and techniques are the responsibility of medical professionals. The described implant procedures are furnished only for informational purposes. Each physician must apply the information in these instructions according to professional medical training and experience.

The lead is not designed, sold or intended for use except as indicated.

Included Item The following items are packaged within the lead package:

- Bipolar Lead Model 3851 VB PRO MRI lead
- Suture Sleeve
- Straight stylet Soft^a
- Two Straight stylet Hard^b
- Vein lifter
- Literature

a. Blue handle, 0.014 inch (0.35 mm) diameter

b. Red handle, 0.014 inch (0.35 mm) diameter

Opening Instruction

The outer package (*figure 4*) and sterile tray may be opened by authorized personnel under clean conditions. To ensure sterility, the sealed inner sterile tray must be opened using accepted aseptic technique by scrubbed, masked, sterile gowned personnel. The sterile tray is opened by peeling back the cover

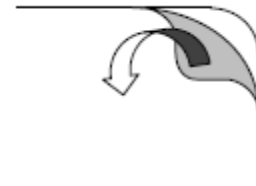

Figure :4
Tray Peeling

Sterilization

Pacetrnix Sterilizes the lead & accessories with ethylene oxide gas (EO) before final packaging. When they are received, they are sterile and ready for use. Bipolar Lead Model 3851 VB PRO MRI lead is supplied by the manufacturer in a sterile state provided the container is intact. If the container is wet, damaged, punctured or if the seal is broken return the lead to the Pacetrnix representative. Never attempt to resterilize the lead. Instead return the lead to Pacetrnix.

If the package has been opened and the lead has not been used, it should be sterilized again with Ethylene oxide gas (only in Pacetrnix).

The lead & accessories should not be sterilized using an autoclave. It should

neither be cleaned using ultrasound. In sterilization, the lead should be packed in a permeable box with Ethylene oxide gas. The temperature of the process should not exceed 50°C (122°F). The necessary cautions should be taken in order to eliminate the Ethylene oxide vestiges before doing the implantation.

The efficacy of the sterilization process should be controlled through biological methods. Never attempt to resterilize a lead or its accessories at implant site.

A Bipolar lead Model 3851 VB PRO MRI that has been explanted for any reason must not be re-used for implantation in another patient.

Surgical preparation

Instrumentation for heart monitoring, imaging (fluoroscopy), defibrillation (external) and pacing threshold & sensitivity measurements should be available during implantation.

Sterile duplicates of all implantable items also should be available for use if accidental damage or contamination occurs. Always isolate the patient from potentially hazardous leakage current when using electrical instrumentation.

Lead Accessories

Description of accessories packed with bipolar lead.

- **Stylets**

A stylet inserted in the leads aids in positioning the lead tip in the heart. Hard & soft straight stylets, soft J-shaped stylet (on demand only) are packaged with Bipolar lead Model 3851 VB PRO MRI (*figure 5A, 5B & 5C*). Hard or firm stylets with red handle and soft stylets have blue handle. A soft straight stylet is preinserted in the packaged lead.

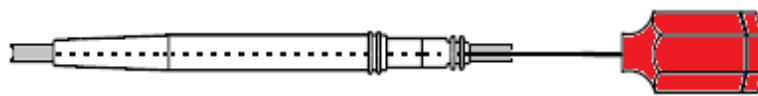
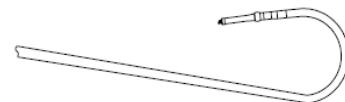

Figure 5A: Red stylet wire (Hard/Firm)



*Figure 5B:
Lead with straight stylet inserted*



*Figure 5C:
Lead with J-Shaped stylet inserted*

- **Suture Sleeves**

The suture sleeve is an adjustable, tubular reinforcement positioned on the outer surface of lead (figure 6). It is designed to secure and protect the lead at the venous entry site after the placement. Using a suture sleeve reduces the possibility of structural damage caused by suturing directly over the lead body.



Figure 6
Suture Sleeve

Caution Do not suture directly over the lead body, as this may cause structural damage. Use the suture sleeve to secure the lead lateral to the venous entry site.

- **Vein Pick**

The vein pick is a sterile, disposable, nontoxic, nonpyrogenic, plastic device designed to assist the physician during the entry of the lead's electrode tip into the vein.

To use the vein pick during a cut down procedure, isolate and open the selected vein using an appropriate scalpel or scissors. Introduce the point of vein pick via this incision into the lumen of the vein (figure 7). With the point of the vein pick facing in the direction of the desired lead passage; gently raise and tilt the pick. Pass the lead under the vein pick and into the vein.

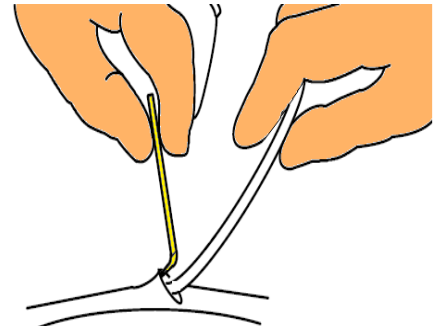

Figure 7
Using the vein pick

Caution The vein pick is not intended either for puncturing the vein or for dissecting tissue during cutdown.

Handling the lead Observe the following when handling the lead.

Warning: *Although pliable, but the lead is not designed to tolerate excessive flexing, bending or tension. This could cause structural weakness, conductor discontinuity or lead dislodgment.*

- Caution**
- *Avoid holding or handling the distal tip of the lead.*
 - *Do not wipe or immerse the electrode in fluid. Such treatment will reduce the amount of steroid available when the lead is implanted.*
 - *Optimum threshold performance might not be achieved if the lead is chronically repositioned because the steroid can be depleted.*
 - *The conductor insulation is silicon rubber, which can attract particulate matter and must always be protected from the surface contamination.*
 - *To prevent damage to the lead or potential lead dislodgement, do not use excessive force or surgical instruments in handling. Use a suture sleeve to avoid placing the lead under extreme tension.*
 - *Do not attempt to alter the electrodes; Do not apply pressure to the tip of the electrode.*
 - *Mineral oil should never come in contact with a tip electrode. Mineral oil on the tip may inhibit tissue growth and conduction.*

Note: *Pacetrnix suggests using sterile water if a lubricant is needed when coupling the lead with the pulse generator.*

6

IMPLANT PROCEDURE

The following sections describe various stages of lead implantation. Procedures included in these sections are only recommendations. Actual implant procedures are left to the discretion of the implanting physician.

It is best to keep the lead and its accessories inside the sterile package until they are to be used.

Caution *Pacing leads should only be implanted in conjunction with continuous fluoroscopic monitoring.*

The lead implant procedure includes the following steps:

- ***Opening a Sterile Package***
- ***Verify lead and connector compatibility***
- ***Inserting the stylet***
- ***Inserting the lead***
- ***Using the vein lifter***
- ***Using the Lead introducer***
- ***Positioning the lead***
- ***Test the lead system.***
- ***Lead Fixation***
- ***Checking lead stability***
- ***Repositioning the Lead***
- ***Intra-Operative measurement***
- ***Securing the Lead***
- ***Connect the lead to the device.***
- ***Test the pacemaker operation.***
- ***Position and secure the pacemaker.***
- ***Lead extraction***
- ***Lead Explantation***

Opening a Sterile Package

A sterile package contains a lead, Vein lifter & stylet set (Firm & Soft). The term sterile pack refers to a set of inner & outer tray. Lead & its accessories are kept inside the inner tray. The pacemaker & wrench is kept in another sterile package and kept inside the inner tray.

Before opening the sterile pack, check for any signs of damage that might invalidate the sterility of the contents. If there is any uncertainty about the sterility, do not implant the pacemaker. Non-sterile lead & its accessories should be returned to Pacetronix.

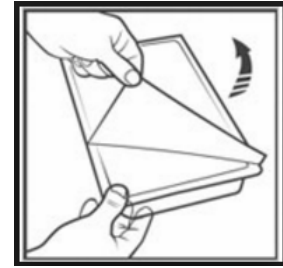

Figure 8: Peeling of tray

Verify lead and connector compatibility

Warning

Verify lead and connector compatibility before using a lead with this pacemaker. Using an incompatible lead may damage the connector, result in electrical current leakage, or result in an intermittent electrical connection.

Table 05: Lead and Connector Compatibility

Lead Model (MRI SAFE)	Polarity	Lead Connector
Bipolar Lead Model 3851 VB PRO MRI	Bipolar / Unipolar	IS-1* BI / IS-1 UNI

*IS-1 refers to the International Connector Standard (see Document no ISO 5841-3) whereas pacemaker and leads are assured of meeting the electrical and mechanical parameters specified in the IS-1 International Standard.

Inserting the stylet

The lead package contains a set of three stylets i.e. two firm/hard stylets & one soft stylet. Choose a stylet according to the function and to the firmness desired. Remove the pre-inserted stylet before inserting another stylet. Make sure the stylet is fully inserted in the lead prior to inserting the lead into the vein. If required the straight stylet can be curved with any sterile smooth surfaced instrument and then carefully insert the curved stylet through the lumen of the conductor.

Caution Do not bend or curve the lead when stylet in place. Bending the lead could damage the conductor and insulation material.

Note: To optimize insertion inside the lead, do not allow body fluids to come in contact with the stylet.

Inserting the lead

The lead may be inserted using one of the following methods:

- **Cephalic Vein**

- ❖ **Via cutdown procedure through a left or right cephalic vein**

Only one incision over the deltopectoral groove (figure 9) is required to insert the lead through the cephalic vein. The endocardial lead is inserted into the right or left cephalic vein in the deltopectoral groove.

The vein pick is packaged with this lead can be used during a cutdown procedure to aid insertion of the lead into the vein.

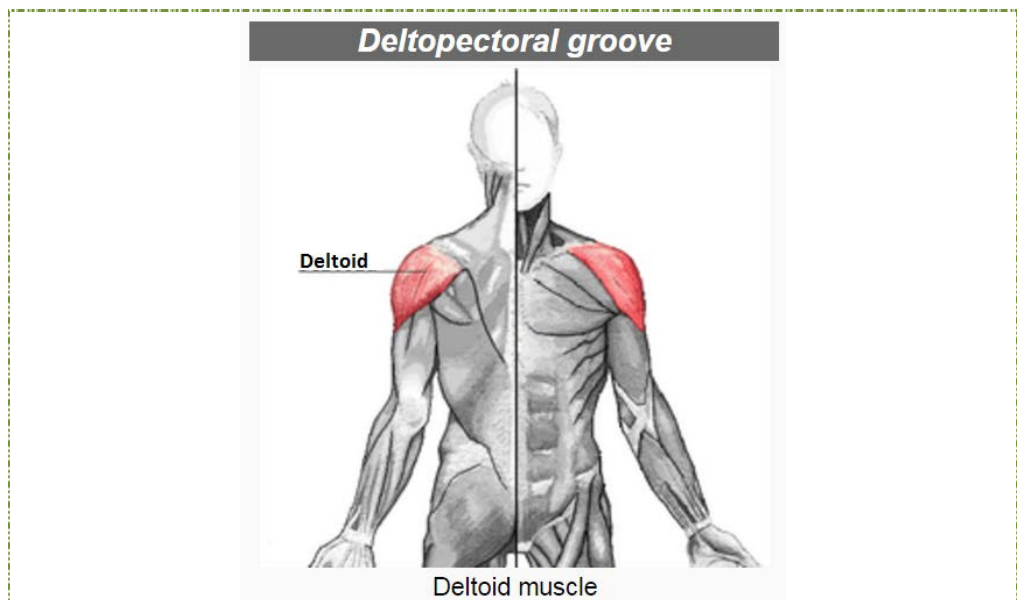

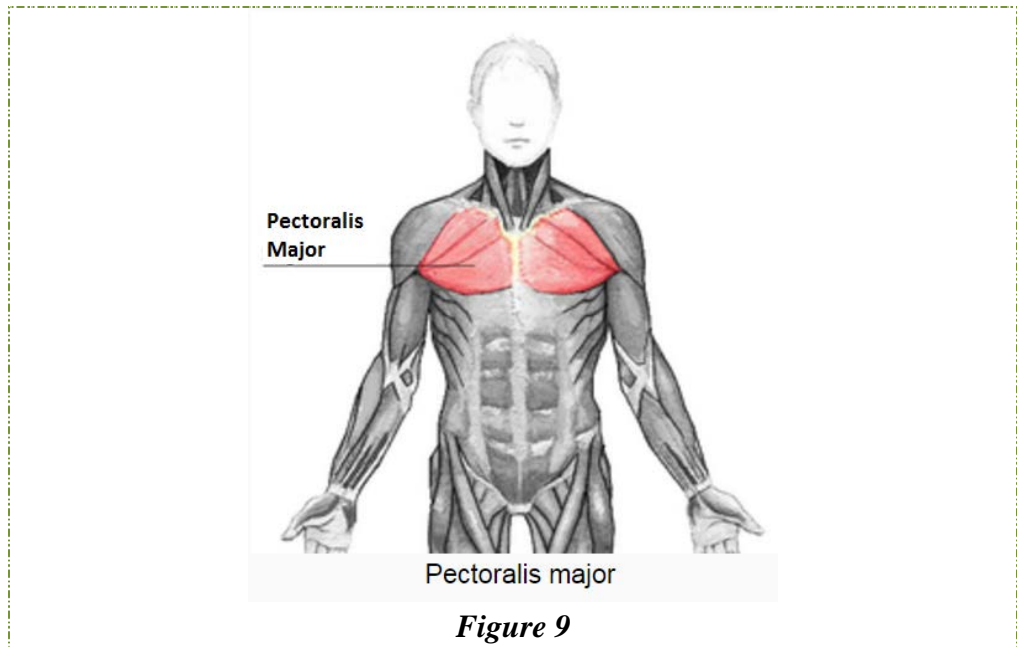

- **Subclavian Vein**

- ❖ **Percutaneously or via cut down procedure through the subclavian vein or internal jugular vein – typically the left subclavian or right internal jugular vein.**

Caution *When attempting to implant the lead via a subclavian puncture, do not insert the lead under medial one third region of the clavicle. Damage to the lead is possible if the lead is implanted in this manner. If implantation via subclavian vein is desired, the lead must enter the subclavian vein near the lateral border of the first rib and must avoid penetrating the subclavius muscle. It is important to observe this implant precaution in order to avoid clavicle/first rib damage or chronic dislodgement to the lead.*

Leads placed by percutaneous subclavian vein puncture should enter the subclavian vein where it passes over the first rib to avoid entrapment by the subclavius muscle associated with the narrow costoclavicular region. Pacetronix recommends introducing the lead into the subclavian vein near the lateral border of the first rib.

The syringe should be positioned directly above and parallel to the axillary vein to reduce the chance that the needle will contact the axillary or subclavian arteries or the brachial plexus. Use of fluoroscopy is helpful in locating the first rib and in guiding the needle.

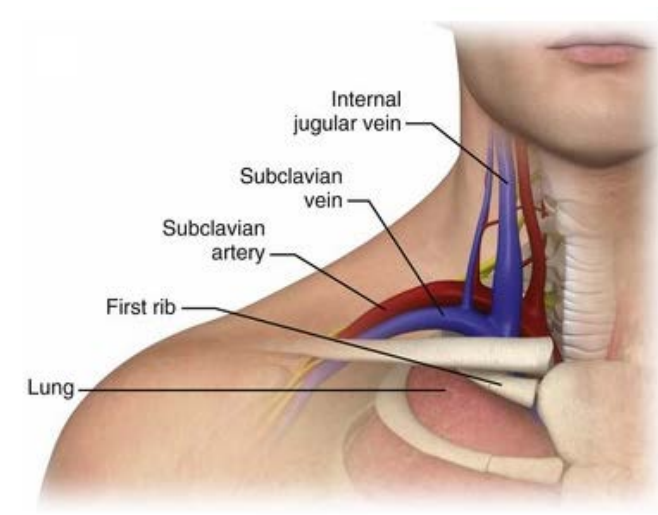

Figure 10: Subclavian Vein

The suggested entry site is the left cephalic vein entered via a venous cut down. Alternatively, the lead may be implanted percutaneously via the left subclavian vein. However, studies indicate that the incidence of lead damage may be decreased with the lead placed by cephalic vein cutdown.

Using the vein lifter

A vein lifter is supplied to facilitate the introduction of the lead into a free-standing vein. Insert the tip of the vein lifter into the vein incision and gently lift it while introducing the lead underneath, into the vein.

Using the lead introducer

If a lead introducer is used, follow the instructions provided with the introducer

- Caution**
- *Be certain the vein lifter does not puncture the silicone rubber insulation of the lead. This could prevent proper lead function.*
 - *Do not use excessive force while inserting the stylet.*
 - *When subclavian vein puncture is used for lead introduction, it is important to insert the lead as lateral as possible during entry of the lead into the vein.*
 - *Avoid positioning the lead so that it become sharply bent or subjected to tension.*
 - *Do not grip the lead with surgical instruments.*
 - *Do not leave a lead unconnected in a patient unless the lead is capped.*

Positioning the lead

- **Ventricular Lead Placement**

- Advance the lead into the Ventricle.
- Pull the stylet back a few centimeters to reduce the risk of the lead damaging the valves or penetrating the heart muscle when it continues down into the ventricle.
- Continue to advance the lead. When the tip reaches the apex, retract the stylet additional ten or more centimeters.
- Use fluoroscopy (lateral position) to ensure that the lead is not lodged in the coronary sinus and is actually in the ventricle.
- If the tip is correctly secured, the lead will be felt to jerk slightly.
- Remove the stylet completely. Adjust the lead so that it lies in the desired position in the ventricle (Figure 11)

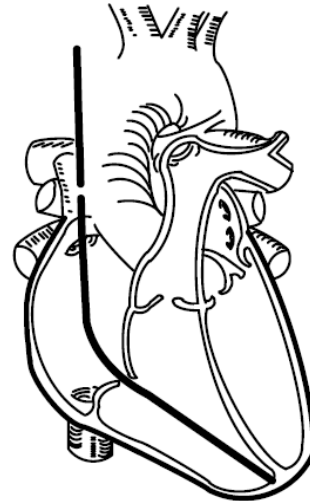

Figure 11
Ventricular Lead Position

Caution

- *If the patient has a thin apical wall, another fixation site should be considered.*
- *If a conscious patient feels a sharp pain, this may be an early indication of perforation.*
- *To minimize the application of lead tip pressure, partially withdraw the stylet during lead positioning to minimize tip stiffness.*
- *See “Lead fixation” on page 29 to secure the lead.*

Test the lead system

To test the lead system during implant we need Pacing System Analyzer (PSA) & its cable. PSA description & its connection to the lead is explained below.

Connections of lead to PSA using cable are as below
(Refer figure 12A & 12B):

Connection between Cable (Banana Pin) & PSA:

- Red banana pin of cable is connected to red collet of PSA.
- Black banana pin of cable is connected to red collet of PSA.

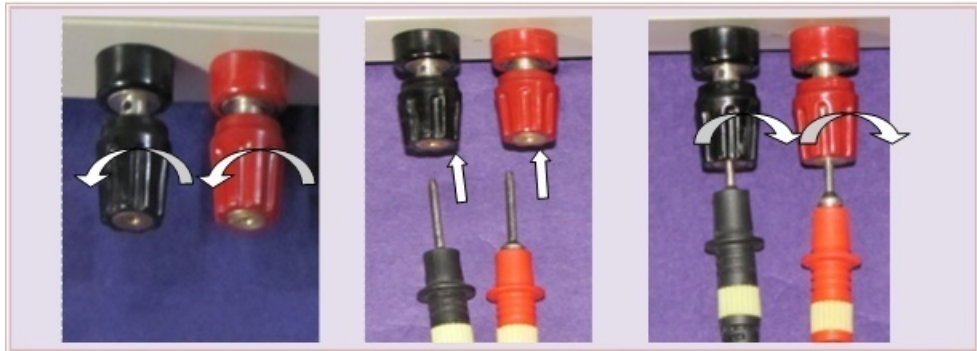

Figure 12A: PSA to Cable connection

Connection between Cable (Crocodile Pin) & Lead:

- Red crocodile pin of cable is connected to Ring (terminal end) of lead.
- Black crocodile pin of cable is connected to Tip (terminal end) of lead.

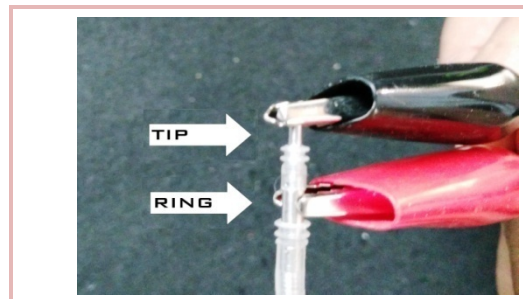

Figure 12B: Lead to Cable connection

PSA Description:

A PSA is used to determine the sensing & pacing threshold, Lead impedance. Pacing threshold of less than 1.0 V is recommended and recommended values for the lead impedance is between 400 ohms to 800 ohms. The lowest possible pacing threshold should be sought to assure optimal long term lead & pacemaker operation. If the procedure is being performed under local anesthesia, remove the stylet from the lead and ask the patient to cough and several deep breaths. After this, reconfirm pacing, sensing threshold & lead impedance. A small deviation in threshold & lead impedance values indicates that the lead is well anchored. The lead may now be secured with suture sleeve & connected to the pacemaker (Refer *Figure 13*).

Lead Fixation

The Bipolar lead Model 3851 VB PRO MRI tip electrode is electrically conductive to measure pacing & sensing thresholds. If the data is acceptable proceed with lead fixation. Pacing/Sensing threshold & lead impedance measurement is done at different Positions till threshold & Impedance are in range (Refer PSA Description).

Note: *The stylet must be fully inserted during fixation or repositioning.*

The Bipolar lead Model 3851 VB PRO MRI is a endocardial passive fixation lead that means the the lead is attached to the heart muscle without a mechanism that holds the end of the lead against the heart muscle.

Passive leads are held against the heart muscle by the pressure exerted by the leads slight stiffness and shape, or by small tynes that grab the lining structures on the inside of the heart.

Use fluoroscopy to ensure proper position of lead in the chamber.

Checking lead stability

After fixation, partially withdraw the stylet 8 to 12 cm. Check the stability of the lead using fluoroscopy. Do not tug on the lead. If possible have the patient cough or take several deep breaths. When the electrode position is satisfactory, completely withdraw the stylet.

Caution *Should dislodgement occur, immediate medical care is required to resolve the electrode position and minimize endocardial trauma.*

Repositioning the lead

If the lead needs repositioning, verify the stylet is fully inserted in the lead, Fluoroscopy can help to verify position of the lead. Reaffix the electrode using handling, positioning and checking lead stability procedures previously discussed.

Intra-operative measurement

Evaluate lead placement to determine P or R-wave amplitude and pacing threshold. Re-verify the electrical performance of the lead before attaching the lead to the pulse generator and after allowing a sufficient time for the effect of local tissue trauma to subside (Approx. 10 minutes).

During implantation, the stimulation threshold and the intra-cardiac signal should be measured using a pacing system analyzer (PSA). A low threshold value and high intra-cardiac signals are signs that the lead has been positioned satisfactorily.

Warning: A pacing lead inserted into the heart presents a direct, low- impedance pathway for current flow to the myocardium. Use only battery-powered test equipment for electrical measurements.

- **Connection to Pacing System Analyzer**

Make sure that the percutaneous lead introducer and stylet are removed from the lead and that is fixated in what is believed to be a suitable location.

Use the PSA cables to connect the terminal pin of the implanted pacing lead to the PSA. It is recommended that the PSA be programmed OFF or passive while connections are being made.

For bipolar leads, the lead terminal pin is the cathode (-) conductor and should be connected to the negative conductor (Black) of the pacing system analyzer’s cable. The ring of the lead terminal is the anode (+) conductor and should be connected to the positive conductor (Red) of the cable. TIP to TIP and RING to RING describes the lead conductor to lead electrode connections.

Caution Carefully apply alligator clips to the lead's connector pin to avoid damaging the insulation between terminals.

Do not use an alligator clip as an indifferent electrode by connecting it directly to tissue. This can result in tissue trauma and cause inaccurate voltage thresholds and impedance measurements.

- **Recommended electrical parameter values**

Table 2 : Recommended Electrical Values

Recommended values at implantation, measured with a PSA	Ventricle data	Atrial data
Voltage threshold*	≤1.2V	≤1.0V
Minimum intra-cardiac amplitude	5 mV	2 mV
Lead impedance typical	400 - 1000 ohms	
* Pulse width setting at 0.4 ms		
Note: After implanting the lead the acute pacing threshold may rise due to local tissue trauma. The threshold will get settle down to nominal threshold value within 30 days (approximately) of implant		

If the initial measurements are different from above recommended above, it is best to wait a while and then repeat the measurements. If the values do

not stabilize at an acceptable level it may be necessary to alter the position of the electrode tip. Verify that measurements fall within the recommended values.

- Note:**
- *Low stimulation threshold reading indicate a desirable safety margin, since stimulation threshold may rise after implantation.*
 - *Initial electrical measurements may deviate from recommendations because of acute cellular trauma. If this occurs, wait approximately 10 minutes and repeat testing. Values may be dependent on patient specific factors such as tissue condition, electrolyte balance and drug interactions.*
 - *Overrotation of terminal pin may increase local tissue trauma and cause temporarily high voltage thresholds.*

Securing the Lead

After the electrodes are satisfactorily positioned, secure the lead to the vein using suture sleeves provided.

A suture sleeve is used to secure the lead to the vein or underlying fascia and to prevent the damage to the insulation of the conductor which otherwise might be caused by the ligature.

Suture sleeve tie-down techniques can vary with lead insertion technique used. Securing the lead will provide permanent hemostasis and lead stabilization.

- Caution**
- *Do not slide suture over electrode ring.*
 - *Suture sleeve sticking can occur. If this occurs, carefully twist the sleeve off the ring towards the connector pin, pulling the suture sleeve when it is positioned over the electrode ring may cause a tear in the lead body near electrode ring.*
 - *Do not kink, twist or braid the lead terminal with other leads as doing so could cause lead insulation abrasion damage.*
 - *While ligating the vein, avoid too tight a stricture. A tight stricture might damage the silicon rubber insulation or sever the vein. Avoid dislodging the electrode tip during the anchoring procedure*
 - *Do not remove or cut the suture sleeve from the lead as it can cause damage.*

- *Ensure the suture sleeve remains proximal to the venous entry site.*

Percutaneous Implant technique

- Peel back the introducer sheath and slide the suture sleeve deep into the tissue (*figure 19*).
- Using the grooves, ligate the suture sleeve and the lead to the fascia. For the additional stability, sleeve may be secured to the lead first before securing the sleeve to the fascia.
- The multiple grooves provide option for tie-down sites. Both the grooves should be used for ligation.

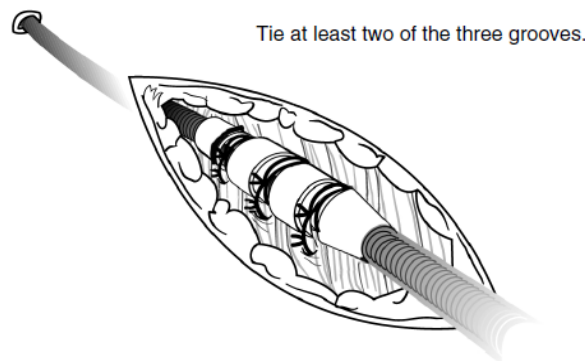

Figure 19

Using the SUTURE SLEEVE with percutaneous implant technique.

- Check the suture sleeve after tie own to demonstrate stability and lack of slippage by grasping the suture sleeve with fingers and try to move the lead in either direction.

Venous Cutdown Technique

- Slide the suture into the vein past the most distal groove. Ligate the vein around the suture sleeve to obtain hemostasis, Next using the same groove, secure the lead and vein to the adjacent fascia (*Figure 18*).
- Using one of the proximal groove, secure the sleeve and the lead to the adjacent fascia. For the additional stability, the sleeve may be secured to the lead first before securing the sleeve to the fascia. The other groove may be used as an additional tie-down site.
- Check the suture sleeve after tie-down to demonstrate stability and lack or slippage bt grasping the suture sleeve with fingers and trying to move the lead in either direction.

Note: *If venous entry is made using a Pacetronix lead introduced, ligate the lead to the adjacent fascia using the suture sleeve to prevent the lead movement.*

Connect Lead to the Device

When the lead is secured at the venous entry site, reverify threshold measurements and connect the lead to the pulse generator using the procedure described in the applicable pulse generator physician's manual.

Warning: Verify that the lead connections are secure. Loose lead connections may result in inappropriate sensing, which can cause inappropriate arrhythmia therapy or a failure to deliver arrhythmia therapy.

- Caution**
- Remove the stylet before connecting the lead to the pulse generator. Under no circumstances should the stylet be left in the lead. Leaving the stylet in the lead could cause:
 - Lead perforation
 - Myocardial perforation, or
 - Inability to remove the stylet and reposition the lead.
 - Insert the IS-1 lead terminal straight into the lead port. Do not bend the lead near the lead –header interface. Improper insertion can cause insulation damage near the terminal ring that could result in damage.
 - Use only the wrench supplied with the device. The wrench is designed to prevent damage to the device from over tightening a setscrew.

- Note:**
- *If necessary, lubricate the lead terminal sparingly with sterile water to make insertion easier.*
 - *If the lead terminal pin will not be connected to the pulse generator at the time of lead implantation, the lead terminal must be capped before closing the pocket incision. Place a suture around the lead cap to keep it in place.*

Giving consideration to patient anatomy and pulse generator size and motion, gently coil any excess lead and place adjacent to the pulse generator. It is important to place the lead into the pocket in a manner that minimizes lead tension, twisting, sharp angles and/or pressure.

In order to correctly connect the leads to the pacemaker, you should carefully follow these steps:

- Check that the setscrew is retracted from the terminal block to ensure that lead passage is clear in the lead cavity. If the lead cavity is obstructed, retract the setscrew to clear it. Do not disengage the

setscrew from the terminal block, see *Figure 14*

- Introduce the lead until its end crosses over the connector. In case of difficulty when connecting the electrode, spin the lead cavity's screw (counter clockwise) with the wrench (screw driver), lubricate the lead with distilled water or with the provided lubricant jelly. The lead's end can be seen at the connector window.

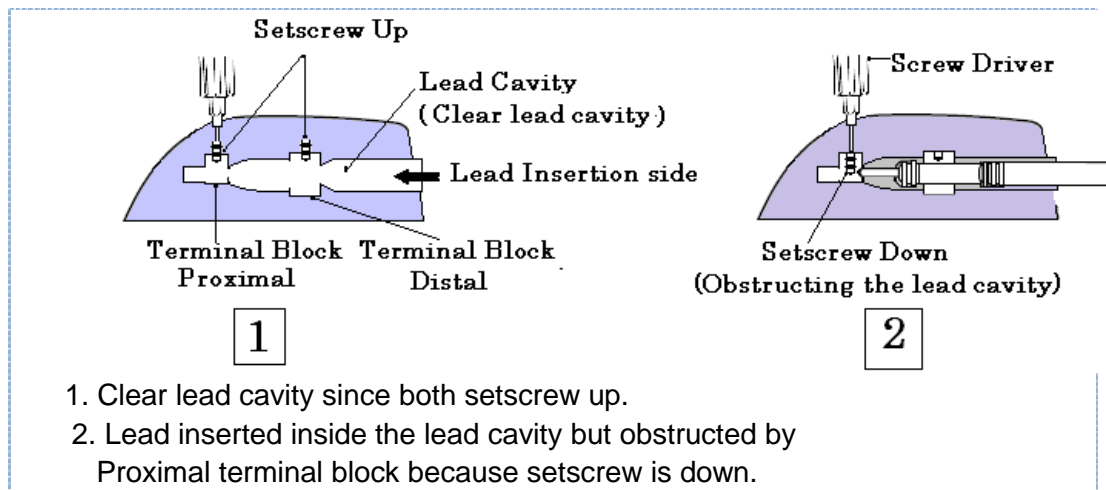
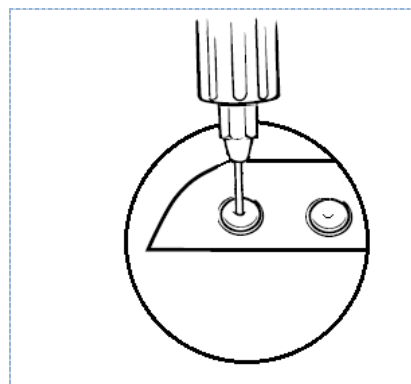

Figure 14: Lead cavity

- The wrench should be introduced in the pacemaker neck through the hole. Leave the wrench in the set screw until the lead is secure. This allows a pathway for venting trapped air when the lead is inserted, see *Figure 15*.



**Figure 15:
Wrench in the Setscrew**

- Push the lead terminal end into the lead cavity until the terminal pin (Tip) is visible in the lead viewing area. Sterile water may be used as a lubricant. Sealant is not required (see *Figure 16*).

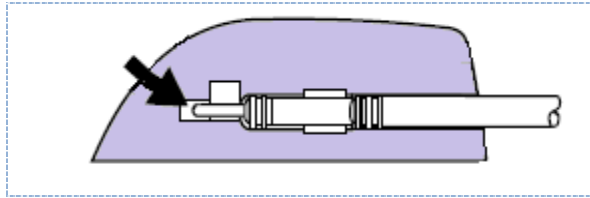

Figure 16:
**Inserting a lead into
the device**

- The lead pin is visible at the end of the viewing area.
- In order to secure the lead, tighten the setscrew by turning the wrench to the right until the wrench clicks (only 2-3 clicks) for both Proximal & Distal end. The stimulation should not start until the screws are firmly adjusted.
- Gently pull on the lead to confirm the connection.
- In order to assure a perfect adjustment, the lead has molded rings; it does not require the use of any additional element for the sealing.

Test the pacemaker operation

Warning: Keep an external Pacemaker INDUS SSB 100 available for immediate use. The external pacemaker is used when the lead is disconnected and pacemaker-dependent patients are without pacing support.

Verify device operation by reviewing an ECG. If pacing and sensing are not adequate, perform one or more of the following tasks:

- Verify the connection of the lead to the pacemaker. Confirm that the lead connector pin appears in the viewing area.
- Disconnect the lead from the pacemaker. Visually inspect the lead connector and lead. Replace the lead if necessary.
- Retest the lead. Inadequate electrical signals may indicate lead dislodgment. If necessary, reposition or replace the lead.

Position & secure the pacemaker

Warning: Electrosurgical cautery may induce ventricular arrhythmias or may cause device malfunction or damage. If electrosurgical cautery cannot be avoided, observe the following precautions to minimize complications:

- Keep temporary pacing and defibrillation equipment available.
- Use short, intermittent, and irregular bursts at the lowest appropriate energy levels.
- Avoid direct contact with the device or leads. If unipolar cautery is used, position the ground plate so the current pathway does not pass through or near the device and lead. The current pathway should be a minimum of 15 cm away from the device and lead.
- Program the device to an asynchronous pacing mode for pacemaker-dependent patients.

Note: Proper device placement can facilitate lead wrap and prevent muscle stimulation. The device may be implanted in right or left pectoral sites.

Either side of the device may face the skin to facilitate excess lead wrap

- a) Verify that Tip & Ring of lead is properly inserted into the proximal & distal terminal block and both setscrews are tight.
- b) To prevent twisting of the lead body, rotate the device to loosely wrap the excess lead length. Do not kink the lead body.
- c) Place the device and leads into the surgical pocket.
- d) Suture the device securely within the pocket. Use non-absorbable sutures. Secure the device to minimize post-implant rotation and migration. Use a surgical needle to penetrate the suture hole on the device.
- e) Suture the pocket incision closed.

Lead extraction	
	<p>Infection of the pacemaker system, particularly sepsis, may require the removal of both the pulse generator and the lead. Multiple abandoned and limitations to venous access are other common reasons to recommend lead extraction.</p> <p>If it is necessary to abandon an indwelling pacing lead, cap its connector pin. Never cut an indwelling pacing lead. Cutting an indwelling pacing lead may cause the insulation to separate from the conductor coil and leave an exposed wire in the body.</p> <p>If a lead must be removed due to infection or other serious reason, exercise great care, as lead extraction carries with it clinical risk.</p>
Note:	<p><i>A pacing lead explanted for any reason should never be implanted in another patient.</i></p> <p><i>It is generally recommended that a chronically implanted endocardial pacing lead not be repositioned except in special circumstances.</i></p>
Explantation	
	<p>If the lead or any portion of it is extracted, handle it according to local regulations. Clean the explanted device with disinfectant and safe disposal. For safety reasons, we recommend that all used leads be enclosed in a protective cover and return to Pacetronix.</p> <p>Examination of explanted leads may provide information for continued improvement in system reliability. Whenever possible, send along a printout of the programmed settings of the pulse generator.</p>
Note:	<p><i>Disposal of explanted devices is subjected to local, state and federal regulations. Contact your Pacetronix representative or call Pacetronix at the phone number on the back of this manual to return the devices.</i></p>

7

WARNINGS

- Exercise extreme caution when testing leads.
- Use only battery-powered equipment during lead implantation and testing to protect against fibrillation which may be induced by alternating current.
- Use only properly grounded line-powered equipment in the vicinity of the patient during the implant procedure.
- Insulate lead connector pins from any leakage currents that may arise from line-powered equipment.
- Avoid diathermy, even if the device is programmed off, as it may damage tissue around the implanted electrodes or may permanently damage the pulse generator

Inspecting the sterile package

Inspect the sterile package before opening it.

- Contact your Pacetronix representative if the seal or package is damaged
- Do not store this product above 50 °C (122 °F).
- Do not use the product after its expiration date.

Sterilization

Company has sterilized the package content with ethylene oxide before shipment. This lead is for single use only and is not intended to be resterilized.

Magnetic resonance imaging (MRI)

An MRI is a type of medical imaging that uses magnetic fields to create an internal view of the body.

Do not conduct MRI scans on patients who have non MRI safe pacemaker and lead implanted. MRI scans may result in serious injury, induction of tachyarrhythmia, or implanted system malfunction or damage.

Diathermy treatment

Diathermy is a treatment that involves the therapeutic heating of body tissues. Diathermy treatments include high frequency, short wave, microwave, and therapeutic ultrasound. Except for therapeutic ultrasound, do not use diathermy treatments on cardiac device patients. Diathermy treatments may result in serious injury or damage to an implanted device and leads. Therapeutic ultrasound is the use of ultrasound at higher energies than diagnostic ultrasound to bring heat or agitation into the body. Therapeutic ultrasound is acceptable if treatment is performed with a minimum separation distance of 15 cm (6 in) between the applicator and the implanted device and leads.

8

PRECAUTIONS

Failure to observe these cautions could result in incorrect lead implantation, lead damage/dislodgement or harm the patient.

Sterilization and Handling

- **For single use only – do not resterilize leads.** Do not resterilize the lead or its accessories packaged with it because Pacetronix cannot ensure that Resterilization is effective. Do not reuse the lead.
- **Sharp objects.** Do not bring the lead into contact with sharp objects which could puncture or otherwise compromise the insulation.
- **Handling.** Avoid handling the lead with any surgical tools such as hemostat, clamps or forceps
- **If package is damaged.** Pacetronix sterilizes the lead and accessories with ethylene oxide (EO) before final packaging. When the lead package received, they are sterile and ready for use. If the container is wet, damaged, punctured return the lead to the company's representative.
- **Use before date.** Do not implant the lead after the USE BEFORE date (appears on the lead packaging) has passed because this date reflects a validated shelf life.
- **Lead Compatibility.** Prior to implantation of this lead confirm lead/pulse generator compatibility by representative of Pacetronix.
- **Defibrillating equipment.** Defibrillating equipment should be kept nearby for immediate use during the implantation procedure.

Lead Evaluation and implantation precautions

- **Vein pick.** The vein pick is not intended either for puncturing the vein or for dissecting tissue during a cut down procedure.
- **Remove Stylet.** The stylet wire must be removed before connecting the lead to the pulse generator.
- **Lead tie-up.** Do not suture directly over the lead body. As this may cause structural damage. Use the suture sleeve to secure the lead at the venous entry site.
- **Do not wipe or immerse** the distal TIP in fluid prior to implant. Such treatment will reduce the amount of steroid available when the lead is implanted.
- **Chronic repositioning.** Optimum threshold performance might not be achieved if the lead is chronically repositioned because the steroid can be depleted.

- **Protect from surface contamination.** The conductor insulation is silicon rubber, which can attract particulate matter and therefore must always be protected from surface contamination.
- **Strain relief.** When implanting the lead via subclavian puncture, allow slack in the lead between the suture sleeve and the venous entry site. This will help minimize flexing at the suture sleeve and the interaction with the clavicle/first rib region.
- **Immersion of lead.** Do not immerse the lead body in mineral oil, or any liquid other than sterile saline or injectable fluid.
- **Flushing a clotted lead.** Flushing a clotted lead can compromise lead integrity. If clotting is suspected, remove the lead from the body and soak the lead in heparinized saline. Insert a guide wire into the distal tip of the lead and advance the wire proximally through the terminal to clear clotting. If unsuccessful, use a new lead.
- **Applying tools to the distal end of the lead.** Applying tools to the distal end of the lead may result in lead damage.
- **Kinking stylet wire.** Do not kink the stylet wire in the lead. Kinking the stylet wire could lock it in the lead or damage the conductor coil.
- **Remove stylet wire.** If the stylet wire cannot be retracted from the lead, withdraw the lead & stylet wire together. Do not implant with the stylet wire inside the lead.
- **Avoid too tight ligature.** When ligating the vein, avoid too tight ligature. A tight ligature might damage the silicon rubber insulation or sever the vein. Avoid dislodging the lead tip during the stabilizing procedure.
- **Do not kink lead.** Do not kink, twist, or braid the lead terminal with other leads so doing so could cause lead insulation abrasion or conductor damage.
- **Do not bend the lead near the lead header interface.** Insert the lead terminal straight into the lead port. Do not bend the lead near the lead header interface. Improper insertion can cause insulation or connector damage.
- **Setscrew adjustment.** The pulse generator's setscrew must be retracted prior to inserting the lead connector. Failure to back off the pulse generator's setscrew may result in damage to the lead(s) and/or difficulty connecting the lead(s)
- **Explanted Leads.** Return all explanted leads to Pacetronix.

POTENTIAL ADVERSE EFFECTS









Possible side effects may give rise to body rejection phenomena including local tissue reaction, muscle and nerve stimulation, infection and embolism, as well as erosion of the implanted device lead through skin, transvenous lead-related thrombosis, and cardiac tamponade. Potential complications associated with the use of the Model 3844 VB lead are the same as with the use of any lead and include:



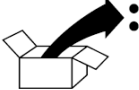

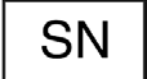

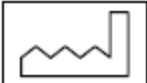
Table 02: Potential Adverse Event

S. No.	Complication	Possible Effects
1)	Perforation of the myocardium	Rupture of the heart muscle wall "Heart block", temporary or permanent loss of stimulation and/or sensitivity, one of muscles or nerves, pericardial rub.
2)	Stimulation of the phrenic nerve	The lead may need to be moved from the side wall
3)	Dislodgment of the electrode tip or a break in the electrical Conductor	Temporary or permanent loss of stimulation and/ or sensitivity
4)	Irritation of the heart muscle	Fibrillation
5)	Transvenous introduction	Air embolism
6)	Increased threshold level	Loss of stimulation
7)	Infection	It may become necessary to perform surgical intervention to remove the lead
8)	Valve damage	It may become necessary to perform surgical intervention to repair the damaged vessel
9)	Tissue necrosis	It may become necessary to perform surgical intervention to remove the lead
10)	Damage to vessels	It may become necessary to perform surgical intervention to remove the lead and/ or repair the damaged vessel

10 SYMBOLS

Explanation of Symbols

Sr. No	Symbol	Symbol Explanation
1.		Operating instructions
2.		Type CF applied part.
3.		Do not dispose of this product in the unsorted municipal waste stream. Dispose of this product according to local regulations
4.		Package contents
5.		Product documentation
6.		Temperature limitation
7.		Serial number
8.		Manufacturer
9.		Date of manufacture
10.		General warning sign

11.		Use By (or Use Before)
12.		Do Not Reuse
13.		Batch Code
14.		Sterile
15.		Sterilized Using ETHYLENE OXIDE
16.		Authorized Representative in the EUROPEAN COMMUNITY"

11 SIDE EFFECTS

Some side effects can be: local reaction, muscular and nervous stimulation, infection, pacemaker or electrode expulsion due to skin alterations, venous thrombosis due to the leads, and cardiac obstruction.

In such cases patient needs an immediate assistance of physician.

12 TECHNICAL SERVICE

Members of the technical services department are available to provide technical consultation 24 hours every day for any questions about the pacing system:

In India: Tel. +91 7292 411105,

Fax +91 7292 400418

Address : Plot No. 15, Sector II, Industrial area,

Pithampur 454775, Dist.: Dhar, Madhya Pradesh

Your local sales representative can also provide assistance.

- Figure 1:** *Lead accessories*
- Figure 2:** *Opening the outer tray*
- Figure 3:** *Opening the inner tray*
- Figure 4:** *Tray peeling*
- Figure 5A:** *Red stylet wire (Hard/Firm)*
- Figure 5B:** *Lead with straight stylet inserted*
- Figure 5C:** *Lead with J-shaped stylet inserted*
- Figure 6:** *Suture sleeve*
- Figure 7:** *Using the vein pick*
- Figure 8:** *Peeling of tray*
- Figure 9:** *Deltpectoral groove*
- Figure 10:** *Subclavian vein*
- Figure 11:** *Ventricular lead placement*
- Figure 12A:** *PSA to cable connection*
- Figure 12B:** *Lead to cable connection*
- Figure 13:** *Using the Suture Sleeve*
- Figure 14:** *Lead cavity*
- Figure 15:** *Wrench in set screw*
- Figure 16:** *Inserting a lead into the device*

14 TABLES

Table 01: Specification

Table 02: Potential Adverse Events

15 DISCLAIMER OF WARRANTIES

Cardiac pacing leads are implanted in the extremely hostile environment of the human body. Leads are necessarily very small in diameter and must still be very flexible, which unavoidably reduces their reliability. Leads may fail to function for a variety of causes, including but not limited to, medical complications, body phenomena, fibrotic tissue formation, displacement, erosion or migration through body tissue, or failure of leads by breakage or by breach of their insulation covering. In addition, despite the exercise of all due care in design, component selection, manufacture and testing prior to sale, leads may easily be damaged before, during or after insertion by improper handling or any other intervening acts. Consequently, no representation or warranty is made that failure or cessation of functions leads, will not occur or that body will not react adversely to the implantation of the leads, or that medical complications (including perforation of the heart) will not follow the implantation of the leads.

However, the manufacturer may select at its discretion to furnish replacement leads at no charge when it appears justified. Used leads returned shall become the property of the manufacturer.

Anesthetic	A substance that produces numbness or sleep
Arrhythmia	An abnormal rhythm of the heart.
Atrioventricular (AV) Node	The small mass of special tissue that delays the energy pulse traveling from the SA Node to the lower chambers (ventricles) of the heart.
Atrium	One of the two upper chambers of the heart, the right atrium and the left atrium. These chambers receive blood from the body and pump it to the ventricles, the lower chambers of the heart. (Plural = <i>Atria</i>)
Atrial	Relating to the atrium
Bradycardia	An abnormally slow heart rate.
Chamber	One of the four areas in the heart that fill with blood before contracting during the heartbeat. The four chambers are: right atrium, left atrium, right ventricle, and left ventricle.
Congestive Heart Failure	The failure of the heart to pump enough blood to the rest of body, resulting in congestion of blood in the lungs and tissues.
Contraction	Heartbeat, A squeezing of the heart muscle that forces blood out of the heart.
Defibrillation	The use of electric shock to correct rapid heartbeats, usually tachycardia or fibrillation. Defibrillators can be paddles on the outside of the chest or small internal electrodes placed directly on the heart.
Dual-Chamber Pulse Generator	A pulse generator with two leads usually connected to the right atrium and right ventricle.
Electrocardiogram	Often called an EKG or ECG, it is a recording of the electrical activity of the heart.
Electromagnetic Interference	Also known as EMI, this is magnetic or electrical interference from machines or devices which can interrupt the normal operation of a pulse generator.
Electro physiologist	A doctor who specializes in diseases of the electrical system of

	the heart.
EMI	See “Electromagnetic Interference.”
Fibrillation	An arrhythmia in which the heart quivers rapidly. Atrial fibrillation occurs in the atrium and is usually not life threatening. Ventricular fibrillation occurs in the ventricles and can be fatal.
General Anesthetic	A medication or group of medications that will make the patient unconscious during surgery.
Intravenous (IV)	Inside a vein.
Lead	A special wire connected to the pulse generator and placed inside the heart.
Local Anesthetic	A medication used in surgery that numbs only one area of the body while the patient stays awake.
Node	A cluster or a place where things join, for example, the Sinoatrial Node is where many nerves join.
Pacemaker	Another term for <i>pulse generator or Implantable cardiac device</i> .
Programmer	A special computer designed to communicate with or “program” an implanted pulse generator.
Pulmonary Artery	A blood vessel that carries blood from the right ventricle to the lungs.
Pulmonary Vein	A blood vessel that carries blood from the lungs to the left atrium.
Pulse	A short burst of electricity.
Pulse Generator	A sealed device containing electronic circuitry and a battery, that is designed to send out electrical pulses and correct problems with the heart’s rhythm.
Rate-Modulated	A pulse generator that can sense a person’s activity and change the heart rate accordingly.
Remote Monitoring	Using a device or machine to transmit information about your pulse generator over a phone line.
Rhythm	The regular beating of your heart.

Single-Chamber Pulse Generator	A pulse generator attached to a single lead.
Sinoatrial (SA) Node	The small mass of special tissue that generates a heartbeat. It is located in the upper right chamber of the heart.
Stimulation Device	Another term for <i>pulse generator</i> .
Tachycardia	An abnormally fast heart rate.
Ventricle	The two lower chambers of the heart. These chambers pump the blood out of the heart into the body.
Ventricular	Relating to the ventricle.